



9ft Double Top Crank & Tilt Solar Market Umbrella

Assembly and User Manual
ITEM: UMB-920120

#M28815



The schematics in this manual are for assembly and operation illustration only. They may differ from the umbrella's actual appearance. Patio stones are not included.



www.atleisure.com
ATLANTA, GEORGIA
Customer Service Toll Free 1-855-880-7205
Monday through Friday from 8:00am-5:00pm
(Eastern Time)



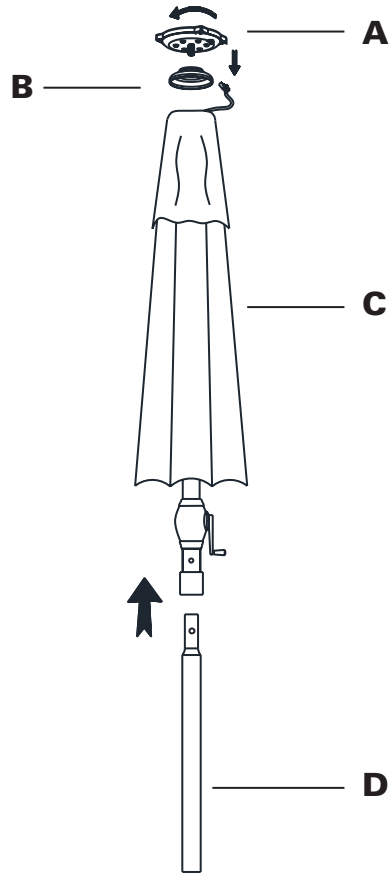

If you have any questions, problems or need additional parts please **do not return** to the place of purchase. Contact our customer service department toll free at **1-855-880-7205** or email us at **customerservice@atleisure.com**

2. Package Contents |

| Replacement Parts 7.

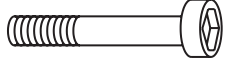
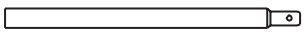
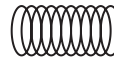
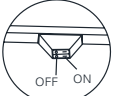

PART	DESCRIPTION	QTY(PC)
A	Solar Panel	1pc
B	Solar Cap	1pc
C	Umbrella Frame with Canopy	1pc
D	Bottom Pole	1pc

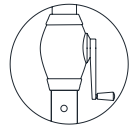
Description	Picture	Re-order No.
Solar panel		SOL-P6P
Solar Cap		#SOL-CAP
Tilt Button		HDW-38ATB-SLVR
Tilt Button Screw		HDW-38ASCW-SLVR
Bottom Pole (Snap In 38mm)		HDW-38ASN-BRZ
Tilt Button Spring		HDW-38ASPG-SLVR
Switch		HDW-2 SWITCH
Canopy (Double Top)		CAN-9M8RBDTO-BR,HG,TO,KH, BR/TAN
Crank		CRK-38A-SLVR

90-DAY WARRANTY

This product is covered under a manufacturer's 90-day warranty from date of purchase against defects in materials and workmanship. This warranty does not cover damage due to neglect, abuse or weather related damage. For full warranty disclosure, email us at customerservice@atleisure.com.

6. How to Replace the LEDs |

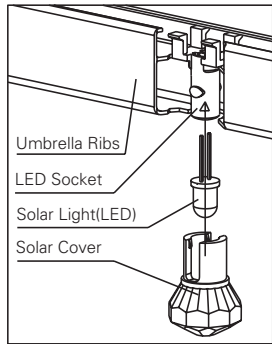

Step 1. Pull out the Solar cover and LED respectively.

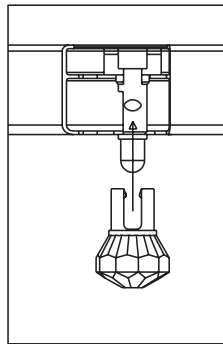

Step 2. Replace with new Solar light (LED) and new Solar Cover if wanted by inserting the new solar light (LED) and new solar cover respectively.

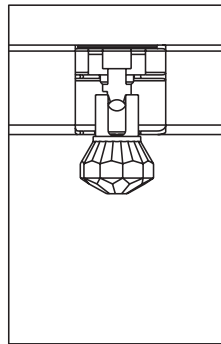

Step 3. Complete.

3 spare Solar Lights (LED) and Solar Covers are provided in the Velcro pouch (same color as canopy) that hangs on the canopy edge. Keep them for future use.

Warnings |

1. Do not use this umbrella during periods of high wind and rain. Failure to do so may result in personal injury and/or property damage.
2. Always take the umbrella down when not in use.
3. Placement of the umbrella over or near a swimming pool can cause premature fading of the canopy. This is not covered under our warranty.
4. To prevent damage to the canopy, open the umbrella facing the opposite direction that the wind is blowing.

CANOPY CARE INSTRUCTIONS:

Simply clean the umbrella canopy with a soft brush and mild detergent.

Do not machine wash.

Do not iron.

Air dry the canopy thoroughly before storing for extended periods of time.

Make sure the canopy is completely open during drying process to prevent shrinkage.

Contact our customer service department toll free at **1-855-880-7205** or email us at customerservice@atleisure.com

| Instructions Of Set-Up & Operation 3.

Before beginning assembly of product, make sure all parts are present. Compare parts with package contents list. If any part is missing or damaged, do not attempt to assemble the product or return to the place of purchase. Contact our customer service toll free at **1-855-880-7205** for replacement parts or further instructions.

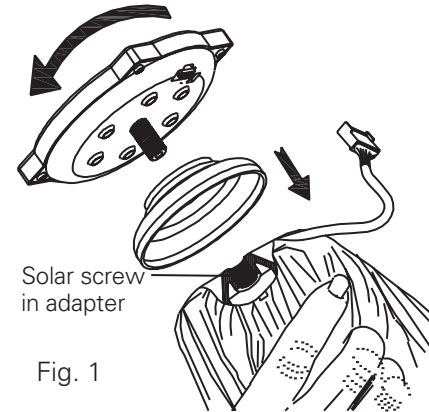

Fig. 1

Step 1. Put the solar cap on the top of umbrella and leave the plug and wire out of the solar cap from underneath. Attach the solar panel and solar cap to the solar screw-in adapter in the top of the umbrella by turning the solar panel clockwise. Do not over tighten.

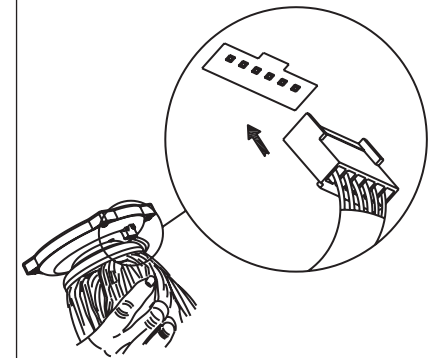

Fig. 2

Step 2. Insert the plug into the socket under the solar panel as shown in Fig. 2.

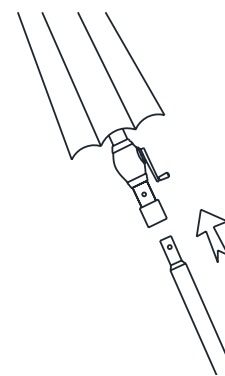

Fig. 3

Step 3. Attach the bottom pole of the umbrella by screwing the threaded ends together. Do not over tighten as it may damage the threads as shown in Fig. 3.

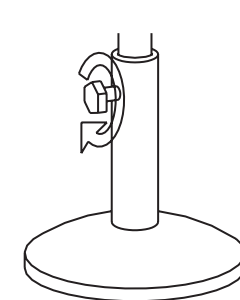

Fig. 4

Step 4. We recommend that you stand and secure the umbrella to an umbrella base (not included). Secure the umbrella pole firmly by tightening the locking nut as shown in Fig. 4.

Contact our customer service department toll free at **1-855-880-7205** or email us at customerservice@atleisure.com

4. Instructions Of Set-Up & Operation (cont'd) |



Step 5. Put the solar umbrella in the sunlight to charge the batteries before the first use as shown in Fig. 5.

Make sure to charge the batteries for at least 8 hours before the first use. Otherwise it will shorten lifespan of the batteries and decrease performance. If charging the solar panel while attached to the umbrella, make sure the switch on the pole is in the off position.



Fig. 5

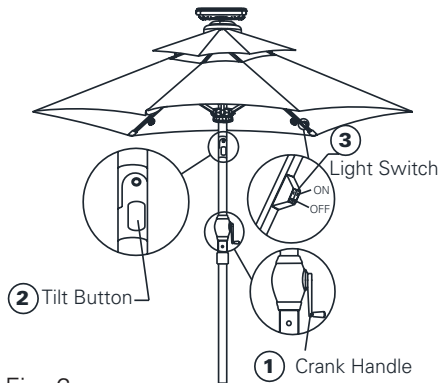

Fig. 6

Step 6. Turn the crank handle in the clockwise direction to open the umbrella canopy, in the opposite direction to close the canopy. To close the umbrella it must be in the upright position. You can tilt the umbrella to your desired angle by pressing the tilt button to release the umbrella top. Release the button to maintain the desired angle. Press the light switch to turn on/off the solar lights.

Reverse the set-up steps above to take down the umbrella.

You must charge batteries before first use.

Please note that batteries can discharge if they are left unused or uncharged for a long period of time. Since there can be a six-month period between production and final customer purchase, we recommend you charge your solar umbrella for at least 8 hours in direct sunlight before the first use. Failure to charge the batteries will result in premature dimming of the lights in your new solar umbrella. Make sure the light switch is in the off position when charging the solar panel.

For everyday normal use, turn on the light switch in the night-time when you want to use solar light and turn off the switch after use. And make sure the light switch is in the off position in the daytime for the solar panel to recharge the batteries.

Please remove the plastic film on all solar panels, hubs, and lights as this protective coating is to prevent damage in shipping

| How to Replace the Batteries 5.

We recommend that you change the batteries in your solar light umbrella every year or when you feel the light output is diminished. Buy three (3) AA size Ni-MH 1200mAh (minimum) (1300mAh are supplied with panel) rechargeable batteries from any major retailer.

Tools required: Phillips head screw driver (not included)

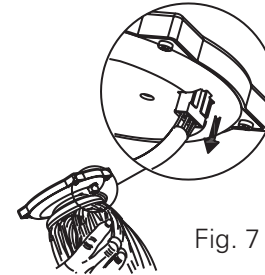

Fig. 7

Step 1. Pull the plug out of the socket under the solar panel. Pull by holding the plug, not by pulling on the wires.

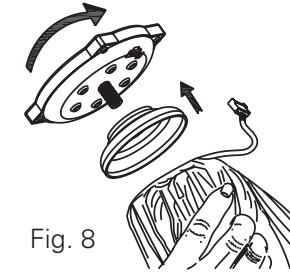

Fig. 8

Step 2. Twist counterclockwise and remove the solar panel from the top of the umbrella as shown in Fig. 8.

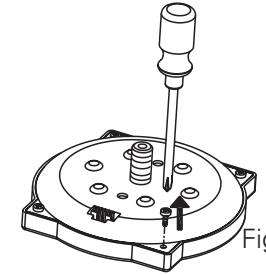

Fig. 9

Step 3. Put the solar panel upside down on a flat, non-abrasive surface to avoid scratching. Loosen all four (4) screws on the solar panel bottom case as shown in Fig. 9.

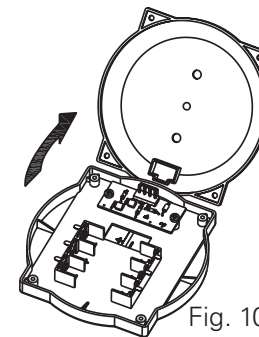

Fig. 10

Step 4. Carefully open the bottom case and set aside. 10. Replace the batteries, matching the +/- on the batteries with the +/- on the battery case as shown in Fig. 10.

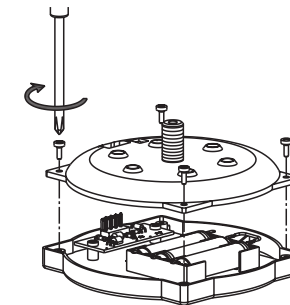

Fig. 11

Step 5. Carefully put the bottom case back. Align the screw holes and replace the screws. Do not over tighten the screws as shown in Fig. 11.

Attach the solar panel back onto the umbrella and recharge the batteries in the sun. Make sure batteries are fully charged before first use.

For everyday normal use, turn on the light switch in the night-time when you want to use solar light and turn off the switch after use. And make sure the light switch is in the off position in the daytime for the solar panel to recharge the batteries.